

# FAROBOATS

THE WORLD'S FIRST FULLY SELF-SUSTAINABLE  
SOLUTION FOR LEISURE BOATING

# ABOUT FAROBOATS

BRINGING SELF-RENEWABLE  
BOATING SOLUTIONS TO THE  
WORLD.



# FAROBOATS

- The world is changing, maritime rules and regulations are changing, our **customers are changing**: environment-consciousness will transform all our businesses.
- And while the **electric boats market is booming around the world**, very few luxury brands have addressed this major shift.
- FaroBoats have gone one step further, by creating the **world's first fully self-sustainable solution for leisure boating**.



# PARTNERS & DEALERS

- Exclusive area, state, region or country
- Non-exclusive

## Canada

- Toronto (tba)

## USA

- Florida (tba)
- Maine (Nova Luxe Yachts)
- Massachusetts (Nova Luxe Yachts)
- New Hampshire (Nova Luxe Yachts)
- New Jersey (Nova Luxe Yachts)
- New York (Nova Luxe Yachts)
- Rhode Island (Nova Luxe Yachts)
- Vermont (Nova Luxe Yachts)

## Europe

- Belgium (PY)
- Denmark (PY)
- Germany (PY)
- Luxembourg (PY)
- Netherlands (PY)
- Portugal (ClubeNZeze)
- Rhone-Alpes, Provence, Côte d'Azur, Aquitaine and Ile-de-France (All Yacht Broker)
- Spain (tba)
- Zurich, Switzerland (tba)

## Middle East (NeoNautica)

- Akrotiri and Dhekelia, Bahrain, Cyprus, Egypt, Iraq, Israel, Jordan, Kuwait, Lebanon, Oman, Palestine, Qatar, Saudi Arabia, Turkey, and United Arab Emirates

## Australia

- New South Wales, Victoria and Queensland (Seavolt)

# THE FARO5



# FARO5

- Our Faro5 Runabout was clearly **inspired by its 1920's ancestors**. The sleek lines of this 16 ft electric-powered boat can only be described as stunning, as it quietly slices the placid waters of the Bajkał Lagoon where it was first trialed in early 2021.
- **Designed by Tomás Costa Lima**, a top Portuguese Naval Designer, who likes to dub it "streamline design" for its clean lines and understated elegance. Its **100% electric**, power-tilt outboard ensures **absolute quietness, flawless performance** and **ample autonomy**.

*Faro*  
ELECTRIC BOAT





# FARO5

- It **seats 5 in ample comfort**, with its bow seats hidden and flush with the top deck when not in use.
- **Exquisite details** around the cockpit, with full controls and status indicators on a single, full-sized LED Monitor.
- Built-in cooler, **spacious storage spaces**, cup holders and top-of-the-line Fusion Stereo System featuring powerful marine speakers complete the **luxurious detailing of the Faro5**, with many more optional features under development.



# FARO5

## Technical Specifications

Length	5 m
Beam	2 m
Electric Motor	from 6.0kW ~ 30.0 kW
Batteries	LiFe / Lithium
Pax	5
Draft	0,4 m

### Each Faro5 is Unique

The hull is carefully handcrafted using cryptomeria, a very particular kind of wood from the Azores Islands, where it's forestry-certified. With innovative technology, we crafted a luxurious boat with a stronger hull and a lighter top deck that is fully protected by epoxy resin.

Even every fibre Faro5 can be unique, with bespoke colours and designs.

## Versions

Wood



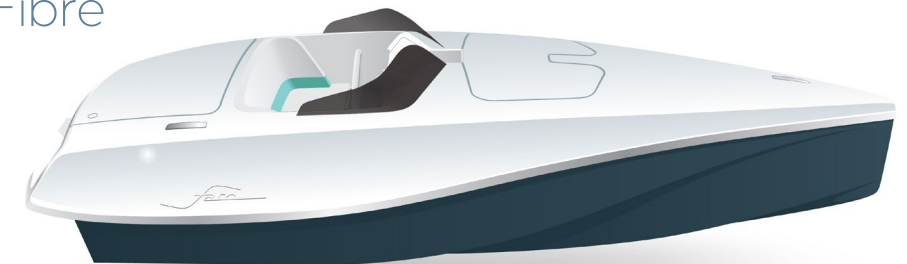

Fibre





# FARO5

## Performance

ENGINE	BATTERIES	TOTAL CAPACITY	 BATTERY LIFE @ 5 KNOTS	 TOP SPEED
30.0 kW Huracan	1 Battery 1 x Lithium 250V 100Ah	25 kWh	8 hours	22 knots
15.0 kW RIM Drive Technology	2 x Batteries LiFePO4 48V 200Ah	2 x 9,6 kWh	8 hours	8 knots
11.0 kW RIM Drive Technology	2 x Batteries LiFePO4 48V 200Ah	2 x 9,6 kWh	8 hours	6 Knots
6.0 kW Torquedo Cruise 6.0 RL	2 x Batteries Lithium Power 48-5000	2 x 5 kWh	8 hours	6 knots

Kilowatt-hours (kWh) = Amp-hours (Ah) × Voltage of battery (V) ÷ 1,000

1 knots = 1.852 kilometers per hour

1 kW = 1.341 hp (horsepower)



# RANGE FARO5

## FARO5 – WOOD VERSION



### ENGINE + BATTERIES

### PRICE\*

30.0 kW

126.500 €

15.0 kW

114.500 €

A 1920's inspired Runabout that is guaranteed to turn heads. Sleek, streamline design, deep V-shaped hull for seaworthiness, and the **uniqueness of the cryptomeria wood decking that clearly conveys exclusive luxury.**

## FARO5 – FIBRE VERSION

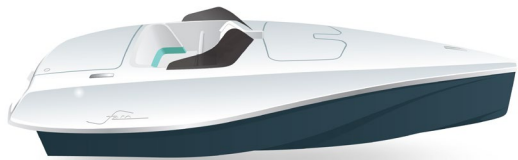

15.0 kW

97.500 €

11.0 kW

85.500 €

6.0 kW

74.500 €

Available in any colour, at customer discretion

The same sleek, streamline design of the Faro5 wood version, but in a practical, **full fibre version** that can be as discreet or as flashy as its owner. Deep V-shaped hull for seaworthiness, with a selected choice of motors for each boating style.

## FARO5 – FIBRE BRANDED VERSION

(Example of one trademark printed)



+ Extra value to be quoted

Designed to incorporate any brand and sail it in style, the **Faro5 branded version** is directed mainly at the **leisure industry**, by providing safe options for boat-renting operations.

\* Ex-works charges.  
Taxes not included.  
Prices for reference only.



# FEATURES & OPTIONS

STANDARD FEATURES & OPTIONS			 FARO5 WOOD VERSIONS	 FARO5 FIBRE & BRANDED VERSIONS
30.0 kW HURACAN	+ Batteries →	1 x Lithium 250V 100Ah	-	
15.0 kW RIM Drive Technology	+ Batteries →	2 x LiFePO4 48V 200Ah	2 x LiFePO4 48V 200Ah	
11.0 kW RIM Drive Technology	+ Batteries →	-	2 x LiFePO4 48V 200Ah	
6.0 kW Torqeedo Cruise 6.0 RL	+ Batteries →	-	-	2 x Lithium Power 48-5000
Custom steering wheel		●	●	●
GPS-enabled dashboard touchscreen		●	●	-
Ergonomic throttle		●	●	○
Magnetic kill switch		●	●	
On-board entertainment system		●	●	●
Bimini top		●		1.600,00 €
Custom boat cover		●		1.400,00 €
Front cushion		●		900,00 €
Custom mini-fridge		●		600,00 €
Wireless induction phone charger		●		360,00 €
Custom painting / decoration		-	Available in any colour / To be quoted	

● Included

- Not applicable / Not available

○ The 6.0 kW version features a computerised throttle with integrated colour display and magnetic kill switch

**Note:** May be subject to VAT or any other local taxes and transport fees.



# THE NEW FARO OPEN



PRE-ORDER ONLY

# FARO OPEN

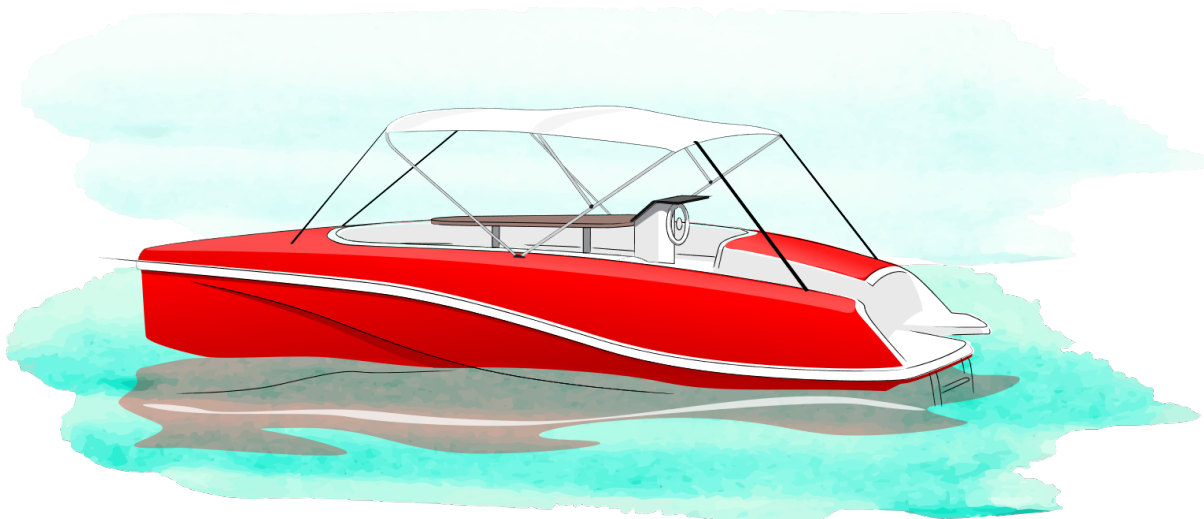

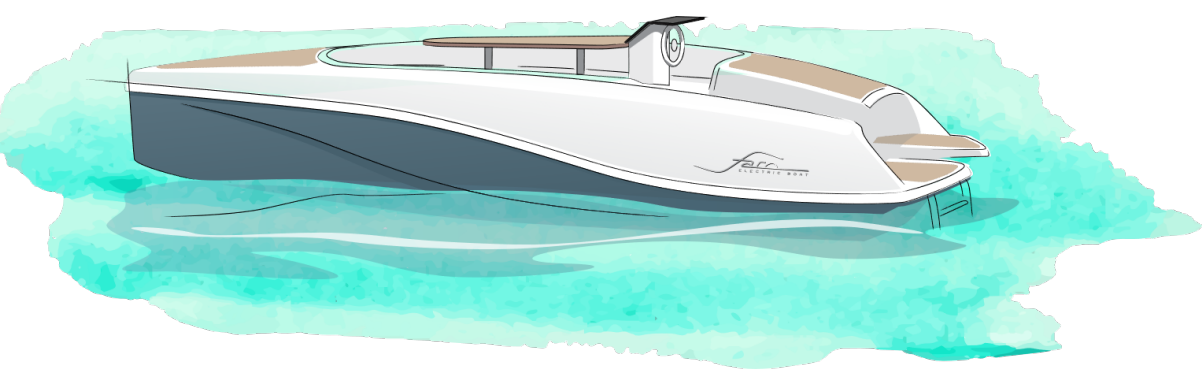

- When boat lovers from across the world showed us their enthusiasm and admiration for the **Faro5** and its **solar charging dock**, we found that quite a few regretted it couldn't carry more than 5 friends or family members at a time.
- This led us to develop **the new Faro Open**, a version of our Faro5 specifically designed for **up to 7 passengers and their gear**.
- **Using the same deep-V-shaped hull as the Faro5**, the new Faro Open can accommodate a large family, a bigger crowd of close friends, or a more substantive group of guests when serving at a luxury waterside property.



# FARO OPEN

PRE-ORDER ONLY

## Performance

ENGINE	BATTERIES	TOTAL CAPACITY	 BATTERY LIFE @ 5 KNOTS	 TOP SPEED
<b>15.0 kW</b> RIM Drive Technology	<b>2 x Batteries</b> LiFePO4 48V 200Ah	2 x 9,6 kWh	8 hours	8 knots
<b>11.0 kW</b> RIM Drive Technology	<b>2 x Batteries</b> LiFePO4 48V 200Ah	2 x 9,6 kWh	8 hours	6 Knots
<b>6.0 kW</b> Torqeedo Cruise 6.0 RL	<b>2 x Batteries</b> Lithium Power 48-5000	2 x 5 kWh	8 hours	6 knots

Kilowatt-hours (kWh) = Amp-hours (Ah) × Voltage of battery (V) ÷ 1,000

1 knots = 1.852 kilometers per hour

1 kW = 1.341 hp (horsepower)



# FARO OPEN

PRE-ORDER ONLY

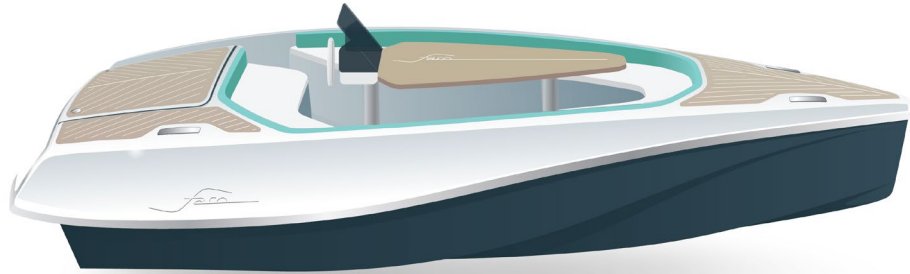

The distinct, deep-V-shaped hull that brought us broad acclaim to our Faro5, but specifically designed for up to 7 passengers and their gear

## Technical Specifications

Length	5m
Beam	2m
Electric Motor	from 6.0kW ~ 15.0 kW
Batteries	LiFe / Lithium
Pax	7
Draft	0,3m

## Pricing

ENGINE + BATTERIES	PRICE*
15.0 kW	97.500 €
11.0 kW	85.500 €
6.0 kW	74.500 €

\* Ex-works charges.  
Taxes not included.  
Prices for reference only.



# FEATURES & OPTIONS

PRE-ORDER ONLY

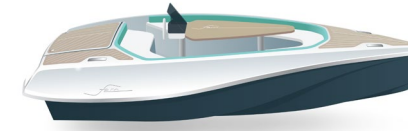

STANDARD FEATURES & OPTIONS			15,0 kW RIM	11,0 kW RIM	6,0 kW TORQEEDO
15.0 kW RIM Drive Technology	+ Batteries →		2 x LiFePO4 48V 200Ah	—	—
11.0 kW RIM Drive Technology	+ Batteries →		—	2 x LiFePO4 48V 200Ah	—
6.0 kW Torqeedo Cruise 6.0 RL	+ Batteries →		—	—	2 x Lithium Power 48-5000
Custom steering wheel			●	●	●
GPS-enabled dashboard touchscreen			●	●	—
Ergonomic throttle			●	●	○
Magnetic kill switch			●	●	
On-board entertainment system			●	●	●
Centre table			●	●	●
Bimini top			●		1.600,00 €
Custom boat cover			●		1.400,00 €
Sun lounger			●		1.200,00 €
Custom mini-fridge			●		600,00 €
Wireless induction phone charger			●		360,00 €
Custom painting			Available in any colour		

- Included
- Not applicable / Not available

- The 6.0 kW version features a computerised throttle with integrated colour display and magnetic kill switch

**Note:** May be subject to VAT or any other local taxes and transport fees.





# THE POWERDOCK



# THE FARO POWERDOCK



Faro boats fully charged in **3 hours to 4 hours**.



Depending on the model you select, the **PowerDock** can be fully recharged within a range of 8 to 17 hours.

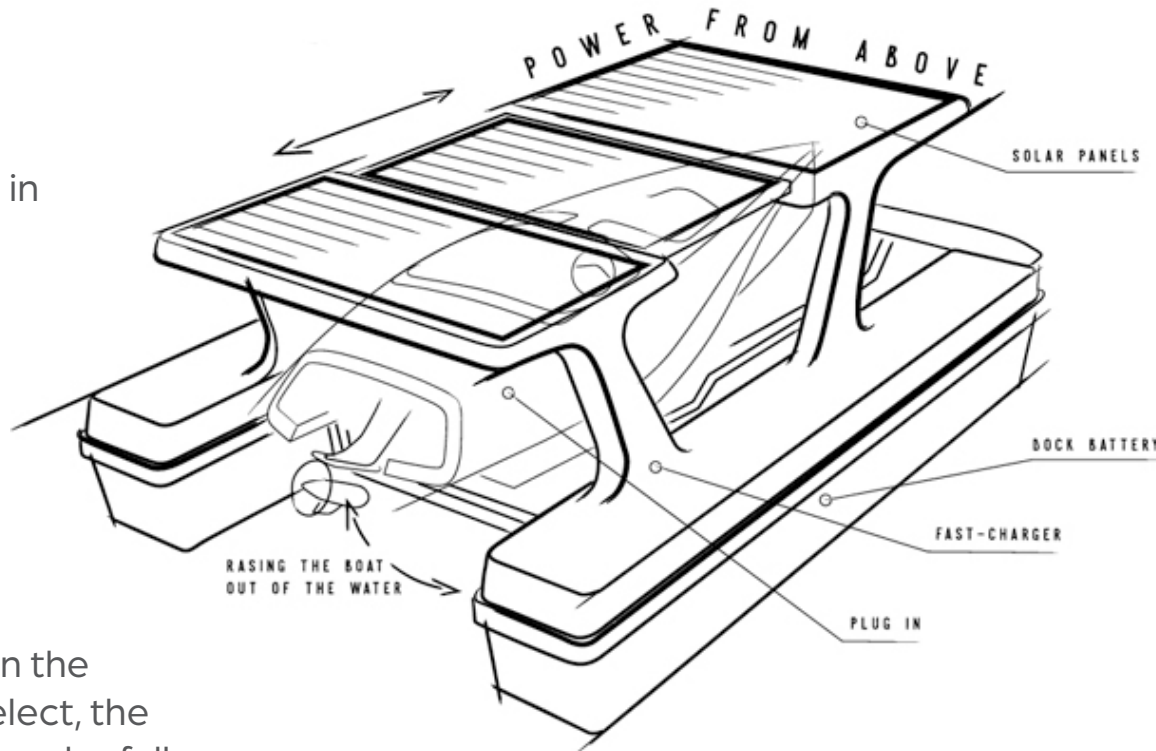

- The floating dock, equipped with solar-charging capabilities, not only charges the Faro boats within a span of **3 to 4 hours** but also can lift them entirely out of the water, ensuring a **dry and fouling-free hull**.
- The **PowerDock** utilizes **solar** and **wind energy** to recharge its batteries, which can be done partially or fully within a day.
- Towable by water, to allow for **full & free autonomy**.

**Note:** This set is available jointly or separately and responds to the new navigation restrictions on boats with combustion engines.

# POWERDOCKS

POWERDOCK CONFIGURATION & CHARGES											
MODELS	STANDARD FEATURES			BATTERIES CHARGED* 75% → 100%    % IN 1 SINGLE DAY		INVERTER ↑ ↓	CHARGER 	FARO BOATS FULLY CHARGED IN			PRICE*
	SOLAR PANELS 	WIND TURBINES 	BATTERY CAPACITY 					6,0 kW Capacity: 10,2 kW (2 x 5,0 kWh)	11,0 / 15,0 kW Capacity: 19,2 kW (2 x 9,6 kWh)	30,0 kW Capacity: 25,0 kW (25,0 kWh)	
	<b>S10</b> The ideal configuration for your 6,0kW Faro5 or Faro Open.	x 6 panels 450W @ 48V Wp: 2700W	—	<b>10,2 kW @ 48V</b> 2 x 25,6V x 200Ah	6h → 8h			100 %	1 x 48V 5000 / 70-50 3,7 kW (40°C)	1 x 3,0 kW	
<b>S20</b> Extra power for full cruising.	—		<b>20,4 kW @ 48V</b> 4 x 25,6V x 200Ah	12h → 16h	50 %	1 x 48V 10000 / 140-100 7,0 kW (40°C)	2 x 3,0 kW	—	3h	4h	145.000 €
	<b>5,2 kW</b> 2 x 500W @48V			10h → 14h	80 %			—	3h	4h	150.000 €
	—			9h → 12h	100 %			—	✓ 3h	4h	155.000 €
<b>S30</b> Max power for top performance.	<b>10,4 kW</b> 4 x 500W @48V		<b>30,6 kW @ 48V</b> 6 x 48V x 200Ah	13h → 17h	70 %	1 x 48V 15000 / 200-100 10,0 kW (40°C)	3 x 3,0 kW	—	—	4h	165.000 €
	—	—		—	—			—	✓ 3h	170.000 €	

✓ Recommended  
— Not applicable / Not Recommended

\* Values considering 8 hours of sun and 12 hours of wind per day.

\* Ex-works charges.  
Taxes not included.  
Prices for reference only.

# INNOVATIVE TECHNOLOGIES



# WE GROW OUR BOATS IN AZOREAN TREES

- The uniqueness of the FARO5 is highlighted by the exquisite hues of the **Cryptomeria japonica** (sometimes called Japanese Cedar), set in long hand-picked slates that are custom-assembled to seamlessly cover its entire top deck.
- The **Faro5 is exclusively produced with FSC certified**, sustainably forested Cryptomeria from the Portuguese Azores Islands.
- This wood is **pleasantly scented, reddish-pink in color, lightweight but strong, waterproof and resistant to decay.**
- A single Cryptomeria tree **can yield 17 Faro5's.**

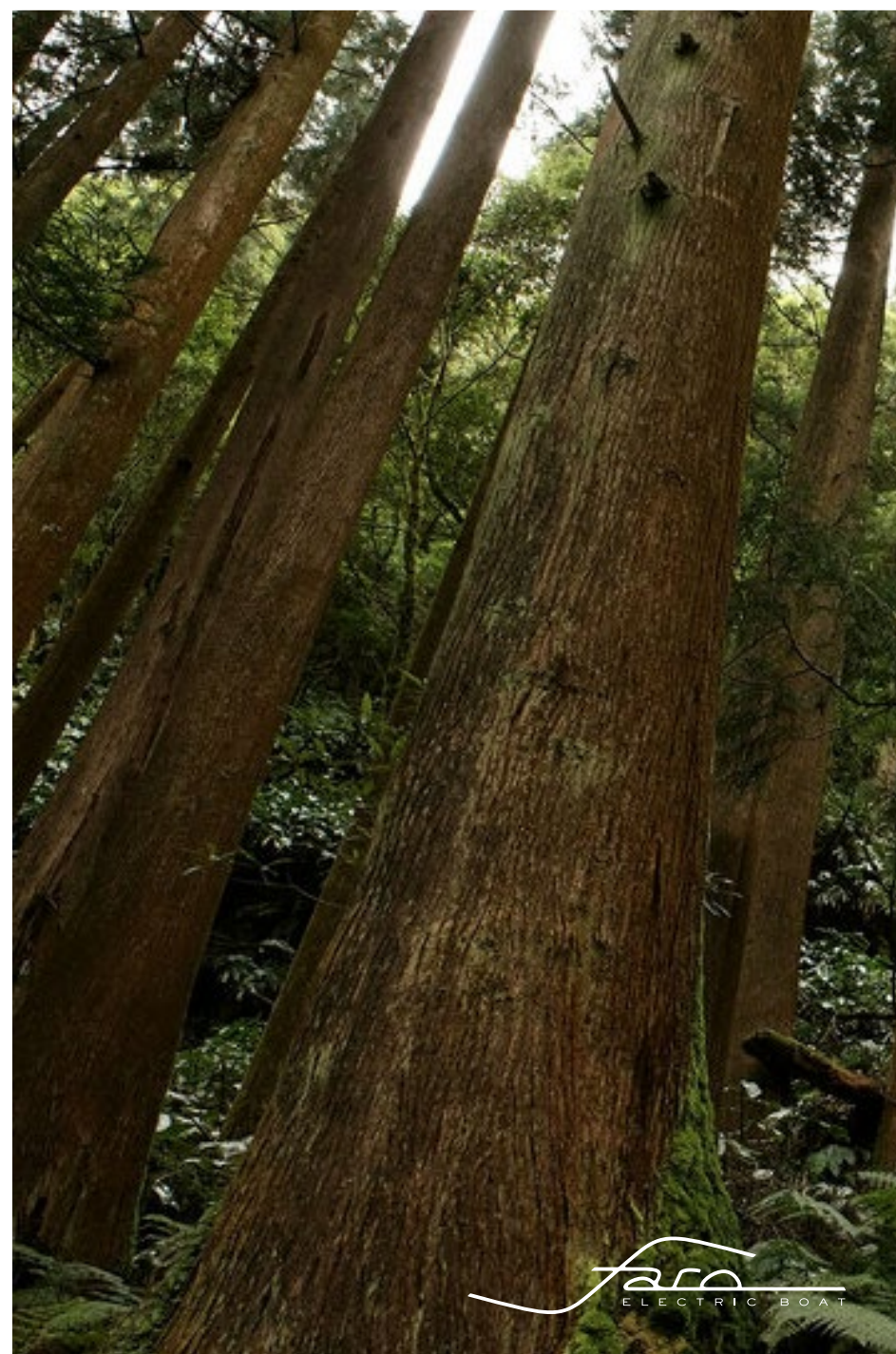

# WE DON'T MANUFACTURE BOATS. WE HANDCRAFT THEM.

- A Faro5 is a Luxury statement. **Each Faro5 Wood is unique**, and there should be no two alike, so we do not mass-produce them.
- Extreme care, aesthetic judgement and attention to detail in **each Faro5 Wood cannot be replicated by machines.**
- The latest technologies go into both the production process and the final product, **but we build each Faro5 Wood one by one.**
- We **hand-pick our fiber** and epoxy resins to be the least harmful to the environment.
- Vacuum-infused into the structure, they merge with the foam-filled hull to avoid air pockets, so we get a **more solid, structurally sound, unsinkable hull.**



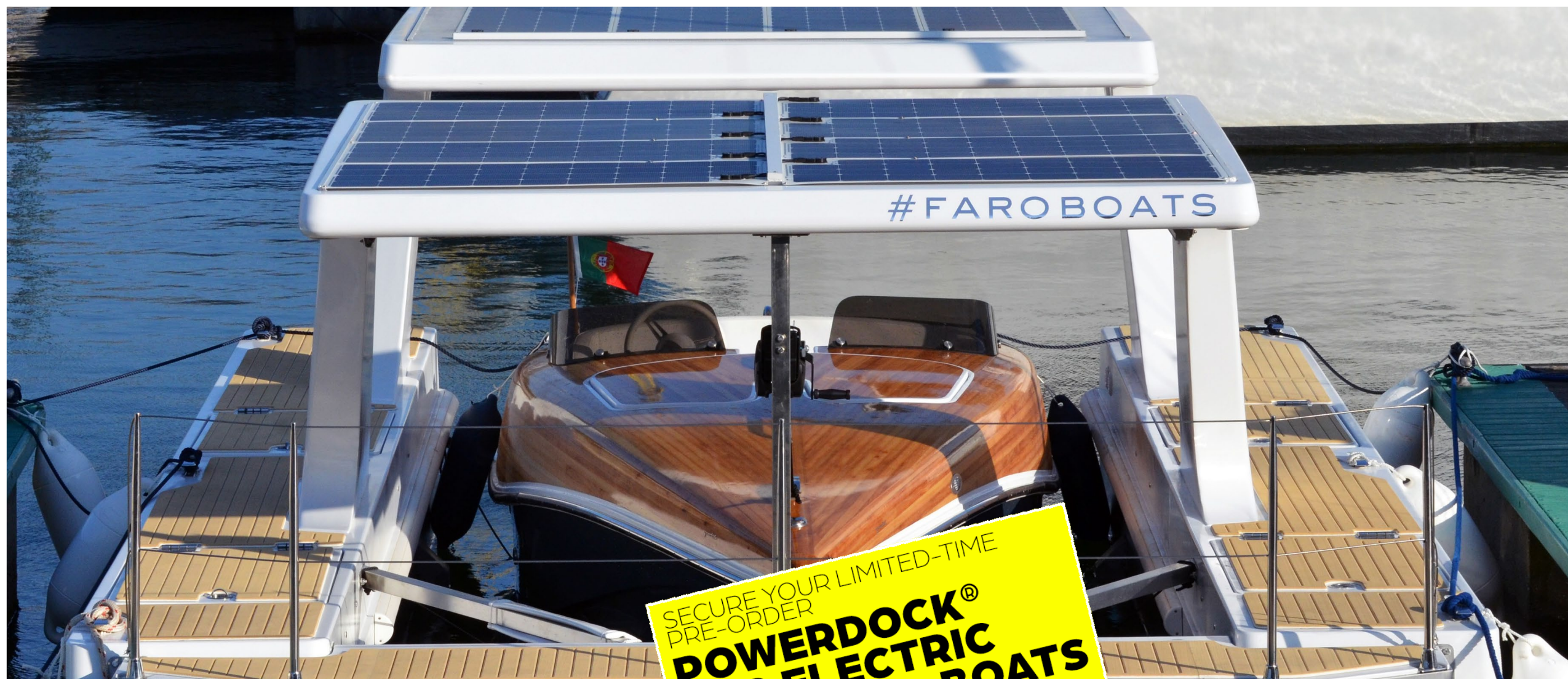

#FAROBOATS

SECURE YOUR LIMITED-TIME  
PRE-ORDER

**POWERDOCK®  
FOR ELECTRIC  
OR HYBRID BOATS  
UP TO 12 METERS**

PRICES FROM €200K  
DELIVERY IN 2025

[Faroboats.com](https://faroboats.com) | [Facebook](#) | [Instagram](#) | [LinkedIn](#)

Av. de Brasília, Doca de Belém – Armazém 10

1300-598 Lisboa

Portugal

*faro*  
ELECTRIC BOAT